



UNIVERSITY OF SCIENCE AND TECHNOLOGY OF SOUTHERN PHILIPPINES
 Alubijid | Balubal | Cagayan de Oro | Claveria | Jasaan | Oroquieta | Panaon | Villanueva

OFFICE OF THE BIDS AND AWARDS COMMITTEE I

BID FORM

NAME OF THE PROJECT : PROPOSED PROCUREMENT OF THE SUPPLY, DELIVERY, INSTALLATION AND COMMISSIONING OF WAN DARK FIBER LEASE AND INTERNET CONNECTIVITY FOR USTP-CDO CAMPUS CY 2026

APPROVED BUDGET OF CONTRACT : FOUR MILLION THREE HUNDRED EIGHT THOUSAND PESOS AND 00/100 (₱4,308,000.00) ONLY

BRIEF DESCRIPTION : SUPPLY, DELIVERY, INSTALLATION, AND COMMISSIONING OF WAN DARK FIBER LEASE AND INTERNET CONNECTIVITY FOR USTP-CDO CAMPUS CY 2026

SOURCE OF FUND : IGF FY 2026

CONTRACT DURATION : THIRTY (30) CALENDAR DAYS (ONE LOT)

ITEM NO.	DESCRIPTION/SPECIFICATIONS	QTY	UNIT	USTP APPROVED UNIT PRICE	UNIT PRICE	AMOUNT																										
1	INTERNET CONNECTION, DARK FIBER CONNECTION – Dark Fiber Lease and Internet Connection Bandwidth 1 GBPS NOTE: Please see attached Terms of Reference	12	months	359,000.00	₱	₱																										
<p>The service provided shall be evaluated based on the following;</p> <table border="0"> <tr> <td>Parameter</td> <td>Service Level Agreement</td> </tr> <tr> <td>Circuitry Availability</td> <td>99.60%</td> </tr> <tr> <td>Round-trip delay</td> <td><200msec (at 50% average traffic utilization)</td> </tr> <tr> <td>MTRrespond</td> <td><30 (phone; 4<hrs (field)</td> </tr> <tr> <td>MTRrepair</td> <td>95% within 4hours, 100% within 8 hours with CBDS</td> </tr> </table> <p>In case the bandwidth is less than the CIR of 90% and in case of service interruption due to the failure of ISP equipment or due to any cause within the Internet Source Provider's exclusive control, the Internet Source Provider, with or without the request of USTP, shall give a rebate of a portion of the monthly contract price based on the following schedule:</p> <table border="0"> <tr> <td>Length of Interruption (minutes)</td> <td>Credit (Day)</td> </tr> <tr> <td>less than 30</td> <td>None</td> </tr> <tr> <td>30 - 179</td> <td>1 / 10</td> </tr> <tr> <td>180 - 359</td> <td>1 / 5</td> </tr> <tr> <td>360 - 539</td> <td>2 / 5</td> </tr> <tr> <td>540 - 719</td> <td>3 / 5</td> </tr> <tr> <td>720 - 899</td> <td>4 / 5</td> </tr> <tr> <td>900- 1440</td> <td>1</td> </tr> </table>							Parameter	Service Level Agreement	Circuitry Availability	99.60%	Round-trip delay	<200msec (at 50% average traffic utilization)	MTRrespond	<30 (phone; 4<hrs (field)	MTRrepair	95% within 4hours, 100% within 8 hours with CBDS	Length of Interruption (minutes)	Credit (Day)	less than 30	None	30 - 179	1 / 10	180 - 359	1 / 5	360 - 539	2 / 5	540 - 719	3 / 5	720 - 899	4 / 5	900- 1440	1
Parameter	Service Level Agreement																															
Circuitry Availability	99.60%																															
Round-trip delay	<200msec (at 50% average traffic utilization)																															
MTRrespond	<30 (phone; 4<hrs (field)																															
MTRrepair	95% within 4hours, 100% within 8 hours with CBDS																															
Length of Interruption (minutes)	Credit (Day)																															
less than 30	None																															
30 - 179	1 / 10																															
180 - 359	1 / 5																															
360 - 539	2 / 5																															
540 - 719	3 / 5																															
720 - 899	4 / 5																															
900- 1440	1																															
					TOTAL:	₱																										

hale

Total Bid Price in Figure: _____
Total Bid Price in Words: _____
Name and Signature of Bidder: _____

All bid proposals must be sealed in envelopes properly labeled and submitted to this University on or before the deadline of submission of bids, **JULY 13, 2026 (MONDAY), 09:30 A.M.** at the Conference Room, Procurement Services Section, 2nd Floor DRER Gymnasium, USTP-CDO Campus, C.M. Recto Avenue, Lapasan, Cagayan de Oro City.

The University of Science and Technology of Southern Philippines – Cagayan de Oro (USTP-CDO) Campus assumes no responsibility whatsoever to compensate or indemnify bidders for any expenses incurred in the preparation of the bid. The USTP-CDO Campus neither assumes any obligation for whatsoever losses that the bidders may incur in the preparation on their bids nor guarantee that an award will be made.

ATTY. JONATHAN S. OCHE
BAC I Chairperson



UNIVERSITY OF SCIENCE AND TECHNOLOGY OF SOUTHERN PHILIPPINES

Alubijid | Balubal | Cagayan de Oro | Claveria | Jasaan | Oroquieta | Panaon | Villanueva

Information and Communication Technology Services – USTP CDO

TERMS OF REFERENCE

Scope of Work

The provider shall lease fiber optic cable infrastructure to establish a Wide Area Network (WAN) connecting the following five (5) external campuses to the USTP CDO Campus via dedicated fiber optic connections:

- Villanueva Campus
- Jasaan Campus
- Balubal Campus
- Claveria Campus
- Lourdes Alubijid Campus

Additional Connectivity Requirements

- **Last Mile Connectivity:** From Lourdes Alubijid Campus to the Research Development Office at the Main Campus in Alubijid.
- **Internet Connectivity:** Dedicated Internet connection at CDO Campus with:
 - Bandwidth: 1 Gbps
 - Committed Information Rate (CIR): 1:1
- **Switching Equipment:**
 - Layer 3 switch at CDO Campus
 - Layer 2 switches at each of the five (5) external campuses
- **Cable TV Access:** Cable TV terminals shall be installed at **all campuses** (CDO and the five external campuses) to access the USTP Cable TV Channel and other available channels in Cagayan de Oro City.

Service Level Agreement (SLA)

- **Wide Area Network via Fiber Optic Cable:** 99% uptime guarantee for the entire contract period.
- **Internet Connection at CDO Campus:** 99% uptime guarantee for the entire contract period.
- **Allowable Downtime:** Limited to unavoidable circumstances such as fiber breaks and preventive/corrective maintenance of the provider's network.
- **Rebate Policy:** Downtime beyond the allowable threshold shall be subject to rebate, computed by the End-User.

Prepared by:

Philip T. Abamonga

Approved by:

ENGR. MARY ANN E. TELEN
DIRECTOR, ICT USTP-CDO

LOCATION	DARK FIBER	INTERNET
CDO	Y	Y
<u>Alubijid</u>	Y	N
<u>Balubal</u>	Y	N
<u>Claveria</u>	Y	N
<u>Jasaan</u>	Y	N
<u>Villanueva</u>	Y	N

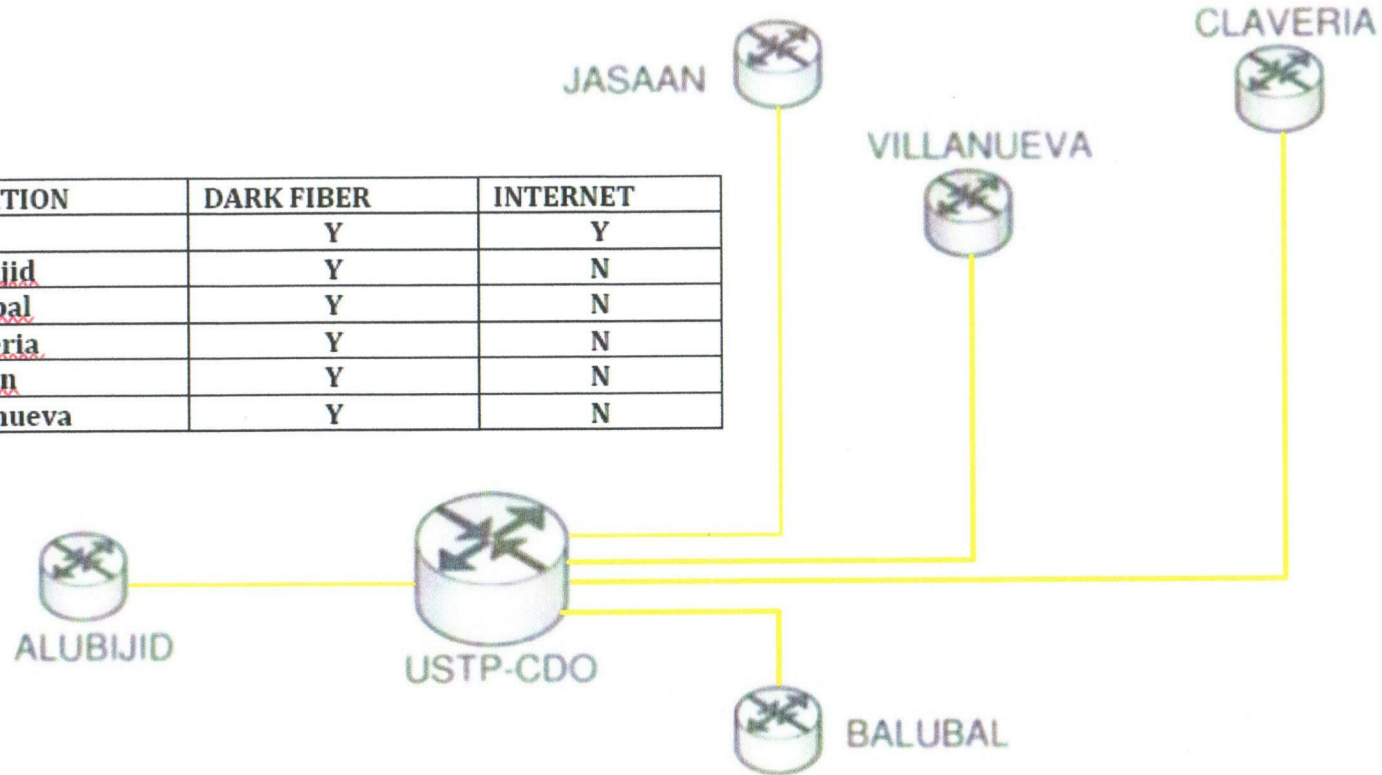

Project Name:	WAN DARK FIBER – LOGICAL CONNECTION	Prepared by:	Approved By:	Sheet No.
Location:	CDO CAMPUS - C.M Recto Cagayan de Oro City	<i>[Signature]</i> PHILIP T. ABAMONGA	<i>[Signature]</i> ENGR. MARY ANN E. TELEN	1
				1



UNIVERSITY OF SCIENCE AND TECHNOLOGY OF SOUTHERN PHILIPPINES

Alubijid | Balubal | Cagayan de Oro | Claveria | Jasaan | Oroquieta | Panaon | Villanueva

Information and Communication Technology Services – USTP CDO

WAN Dark Fiber Rental and Internet Connectivity for University of Science and Technology of Southern Philippines (USTP)

1. ALUBIJID CAMPUS

Location Coordinates: 8.52127, 124.43451

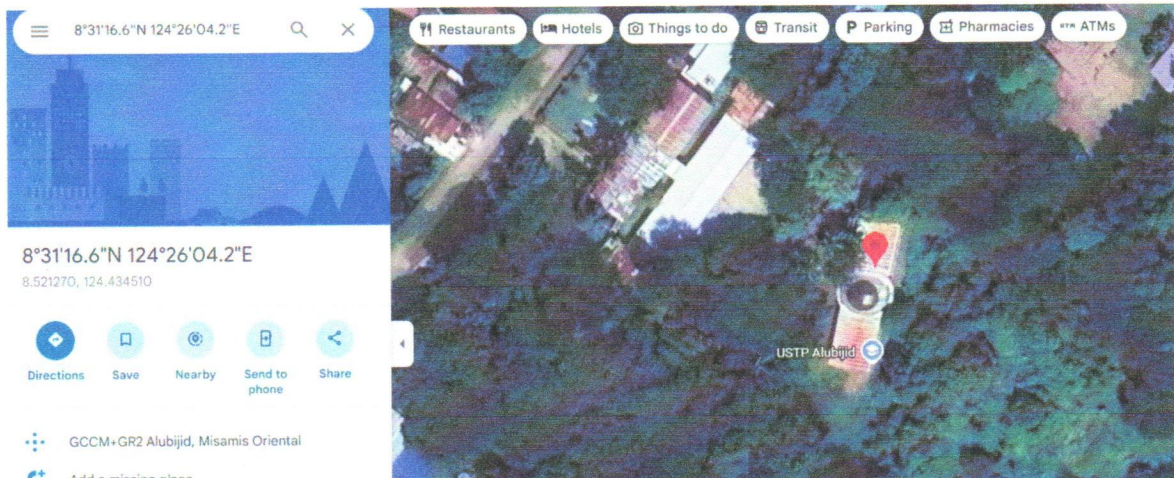

2. ALUBIJID-RDO

Location Coordinates: 8.51666, 124.41609

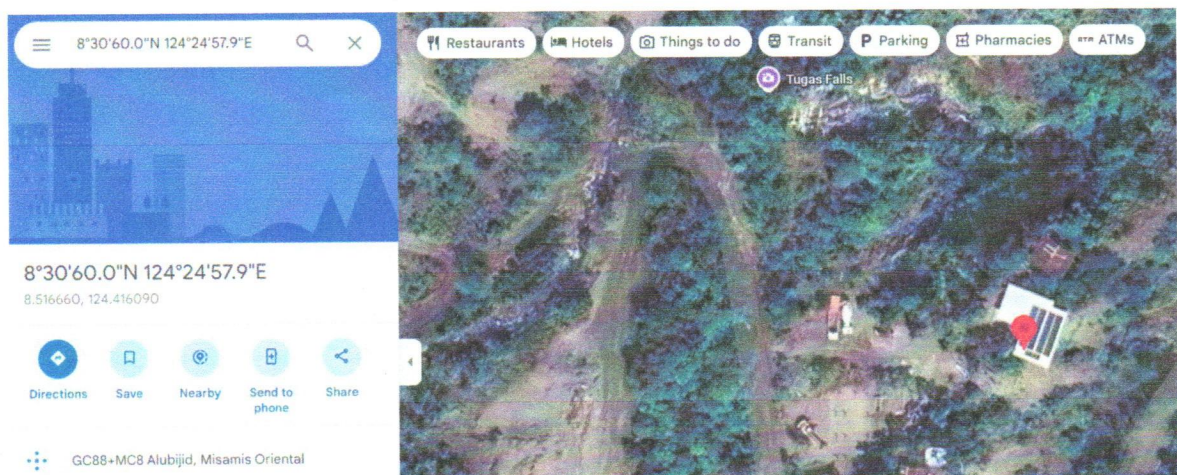



UNIVERSITY OF SCIENCE AND TECHNOLOGY OF SOUTHERN PHILIPPINES

Alubijid | Balubal | Cagayan de Oro | Claveria | Jasaan | Oroquieta | Panaon | Villanueva

Information and Communication Technology Services – USTP CDO

3. BALUBAL CAMPUS(NEW SITE)

Location Coordinates: 8.46446, 124.78675

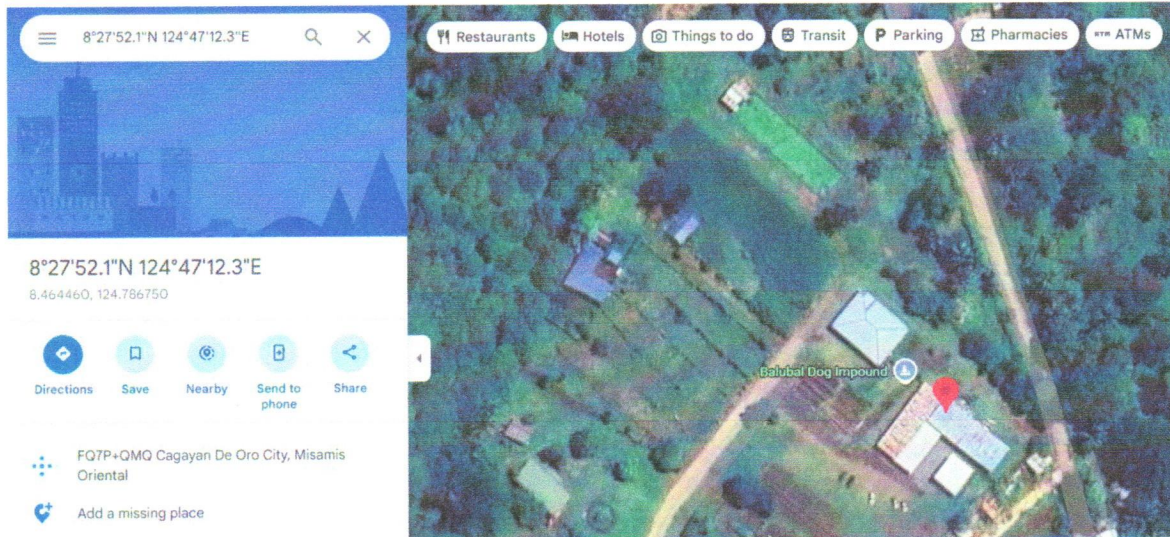

4. CLAVERIA CAMPUS

Location Coordinates: 8.61097, 124.88795

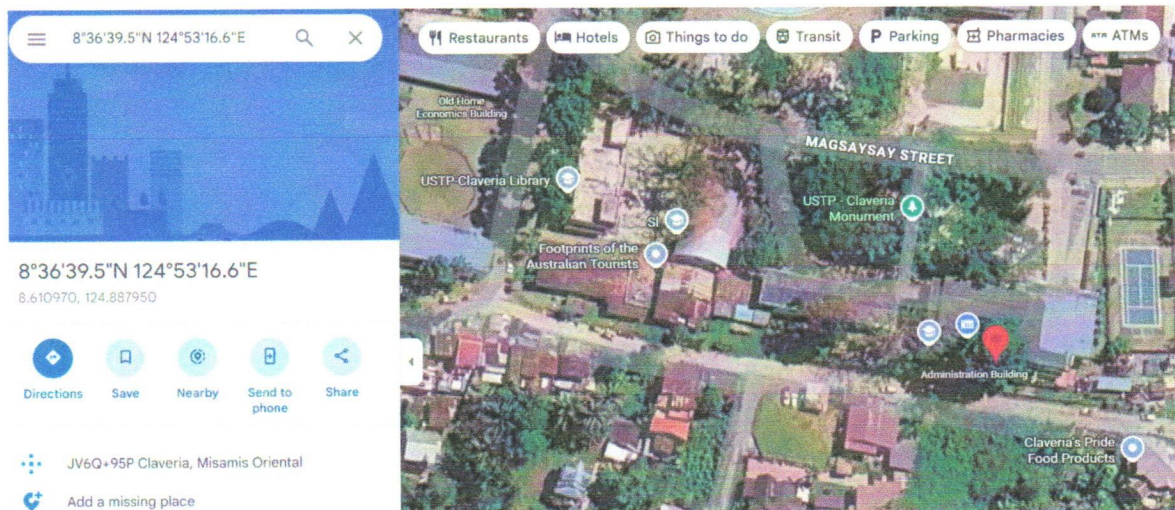



UNIVERSITY OF SCIENCE AND TECHNOLOGY OF SOUTHERN PHILIPPINES

Alubijid | Balubal | Cagayan de Oro | Claveria | Jasaan | Oroquieta | Panaon | Villanueva

Information and Communication Technology Services – USTP CDO

5. JASAAN CAMPUS

Location Coordinates: 8.65496, 124.75337

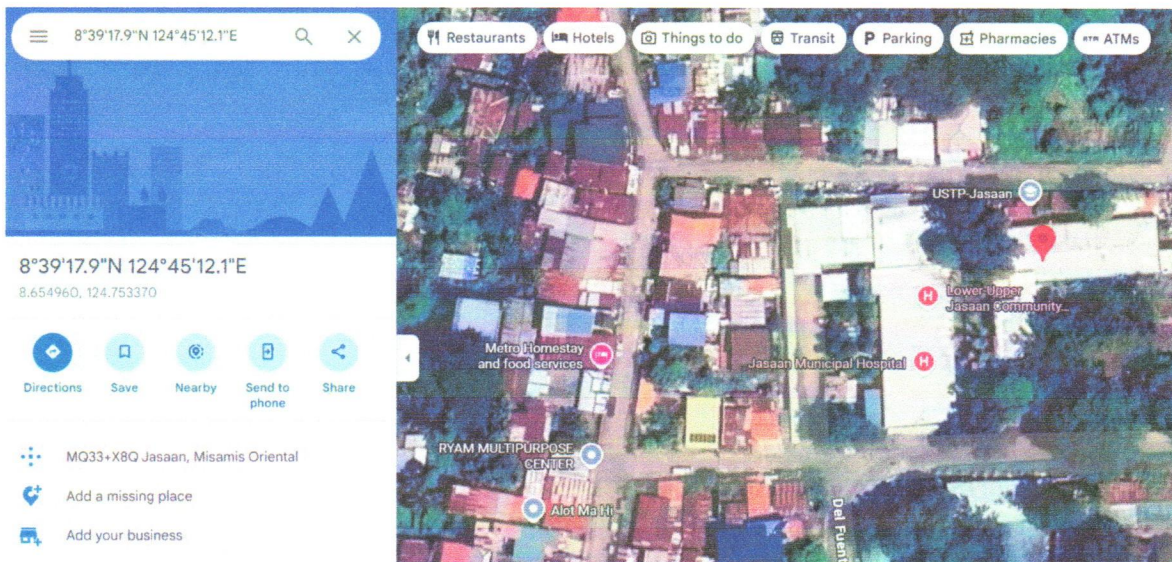

6. VILLANUEVA CAMPUS

Location Coordinates: 8.586272483178256, 124.76973575637076

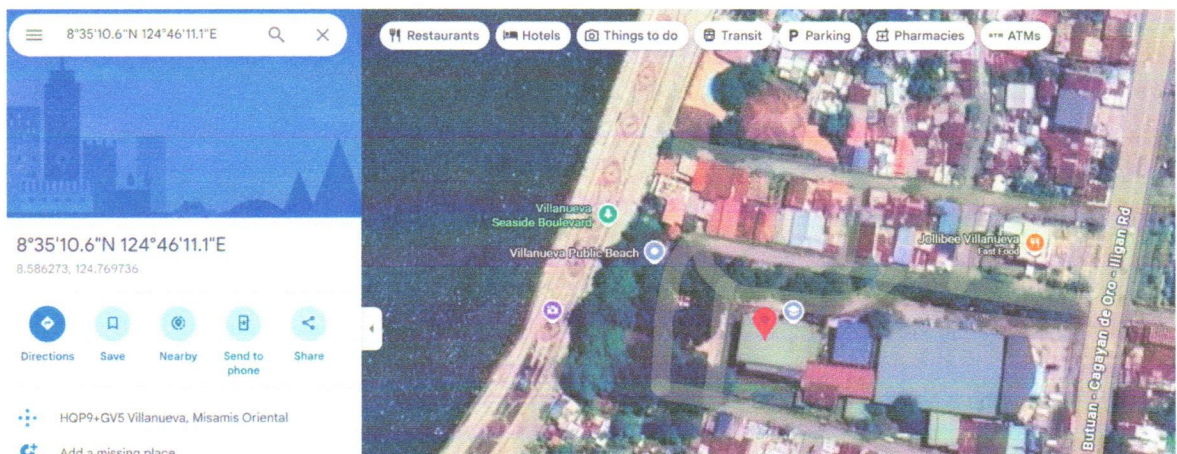

C.M. Recto Avenue, Lapasan, Cagayan de Oro City 9000 Philippines
Tel Nos. +63 (88) 856 1738; Telefax +63 (88) 856 4696 | <http://www.ustp.edu.ph>

